

# **zeagle**®

**SYSTEMS, INC.**

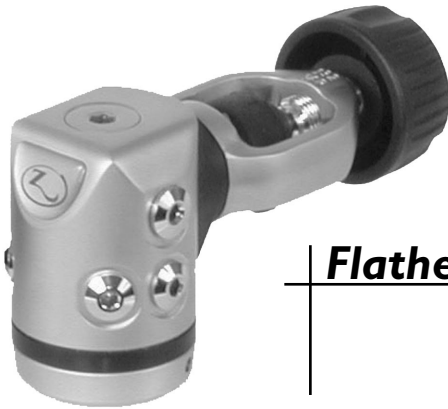

**ZX**



**Flathead VI**

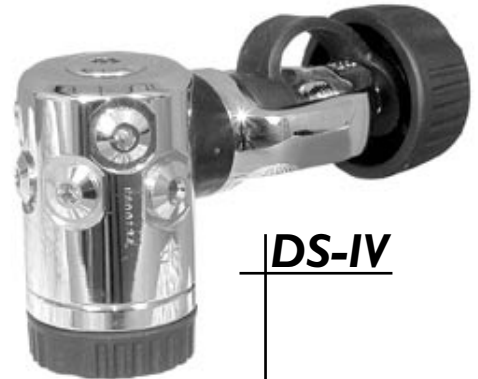

**DS-IV**



**50D**

## **Regulator Service Manual**

**For Zeagle Scuba Regulator Models: 50D, DS-IV, Flathead VI 1st Stages and ZX 2nd Stage, ZX Octo**

## Flathead-VI 1st Stage Parts

ITEM #	PART #	DESCRIPTION.....
1	341-0149-CL	Environmental End Cap
2*	341-0121-MC	Hydrostatic Diaphragm (clear)
3	341-0148-AA	Label (for Flathead-VI)
4	341-0119-KA	Hydro-Transmitter
5	341-0103-CD	Spring Adjuster
6	341-0122-CD	Diaphragm Clamp
7	341-0140-VH	Regulating Spring
8	341-0104-CD	Spring Carrier
9*	341-0105-TA	Internal Diaphragm (black)
10	341-0106-VH	Lifter
11	341-0109-CD	Seat Support
12*	341-0108-JA	Seat (orifice)
13*	160-0009-N9	O-ring (for seat)
15*	160-0011-N7	O-ring (for LP port plugs)
16	341-0127-CD	LP Port Plug (includes O-ring)
17	341-0128-CD	HP Port Plug (includes O-ring)
18*	160-0012-N9	O-ring (for HP port plugs)
19	341-0129-AA	DIN Cap
20*	160-0111-N7	O-ring (for inlet of DIN bolt)
21	341-0112-CD	Din Connector Bolt
22*	341-0139-BA	Conical Filter
23*	160-0011-N7	O-ring (for filter & bolt)
24	341-0142-AA	DIN Wheel
25	341-0115-AA	Yoke Knob Assembly
26	341-0117-LA	Dust Cap
27	341-0111-CD	Yoke Bolt
28	341-0113-DL	Yoke, Satin Finish
29	341-0146-SA	Saddle Spacer
30	341-0107-VH	HP (high pressure) Valve
31	341-0141-VA	Valve Spring
32*	160-0006-N7	O-ring (smallest O-ring in HP balance plug)
33*	160-0905-N9	O-ring (middle sized O-ring on HP balance plug)
34*	160-0016-N7	O-ring (largest sized O-ring on HP balance plug)
35	341-0151-CL	HP Balance Plug
42	341-0145-CL	Body, Satin Finish (for Flathead-VI 1st stage)
43	341-0147-AA	Label
44	341-0150-SA	Trim Ring
45	341-0152-SK	Washer (for DIN Wheel)

\* An asterisk next to the Item Number means that part is included in the Standard Service Kit. The Service Kit Part # for the 1st Stage is 345-1000. The 2nd Stage Service Kit Part # is 345-2000.

**Flathead VI First Stage Assembly**  
**Yoke Model: 310-4110**  
**DIN Model: 310-4120**

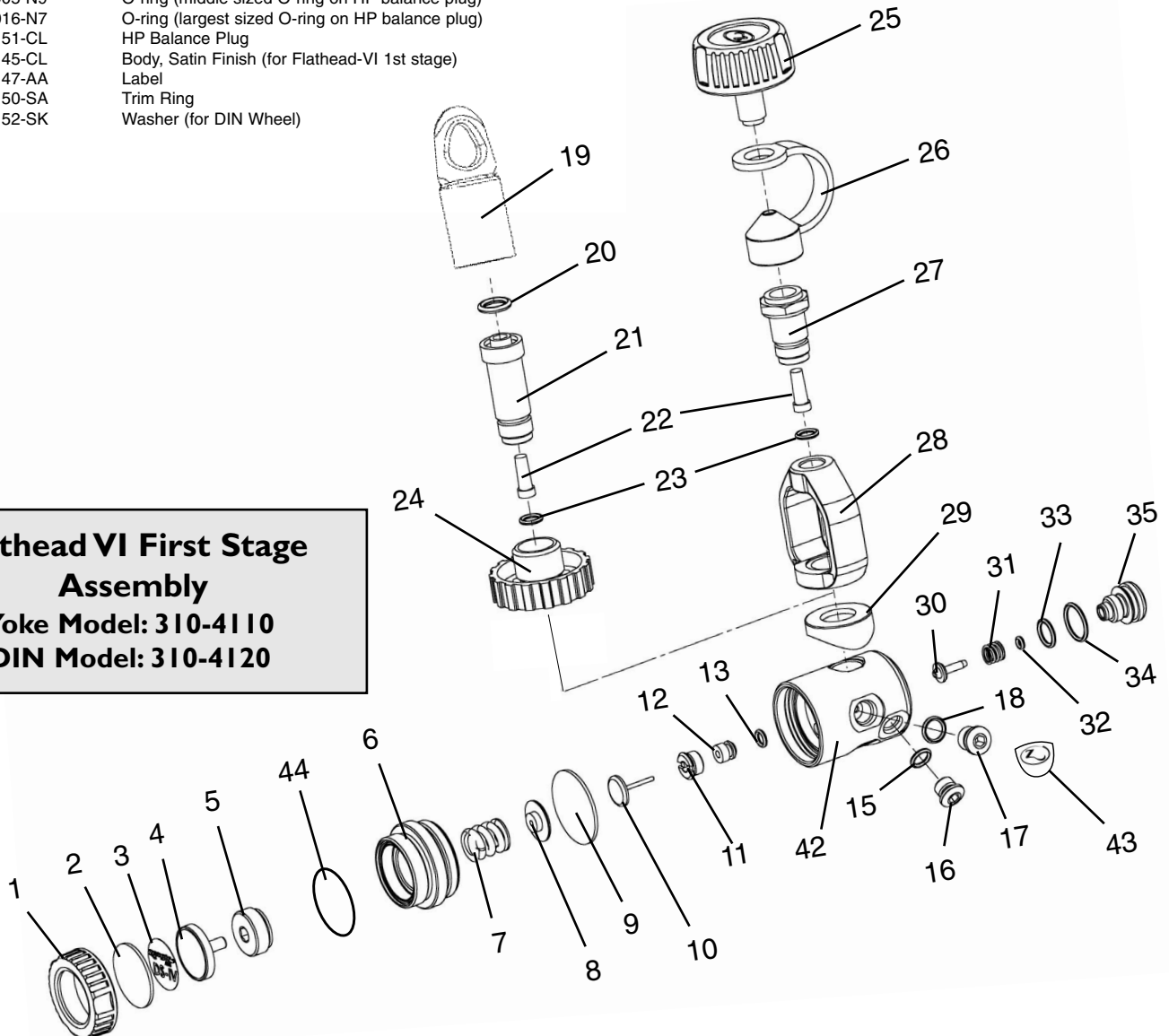

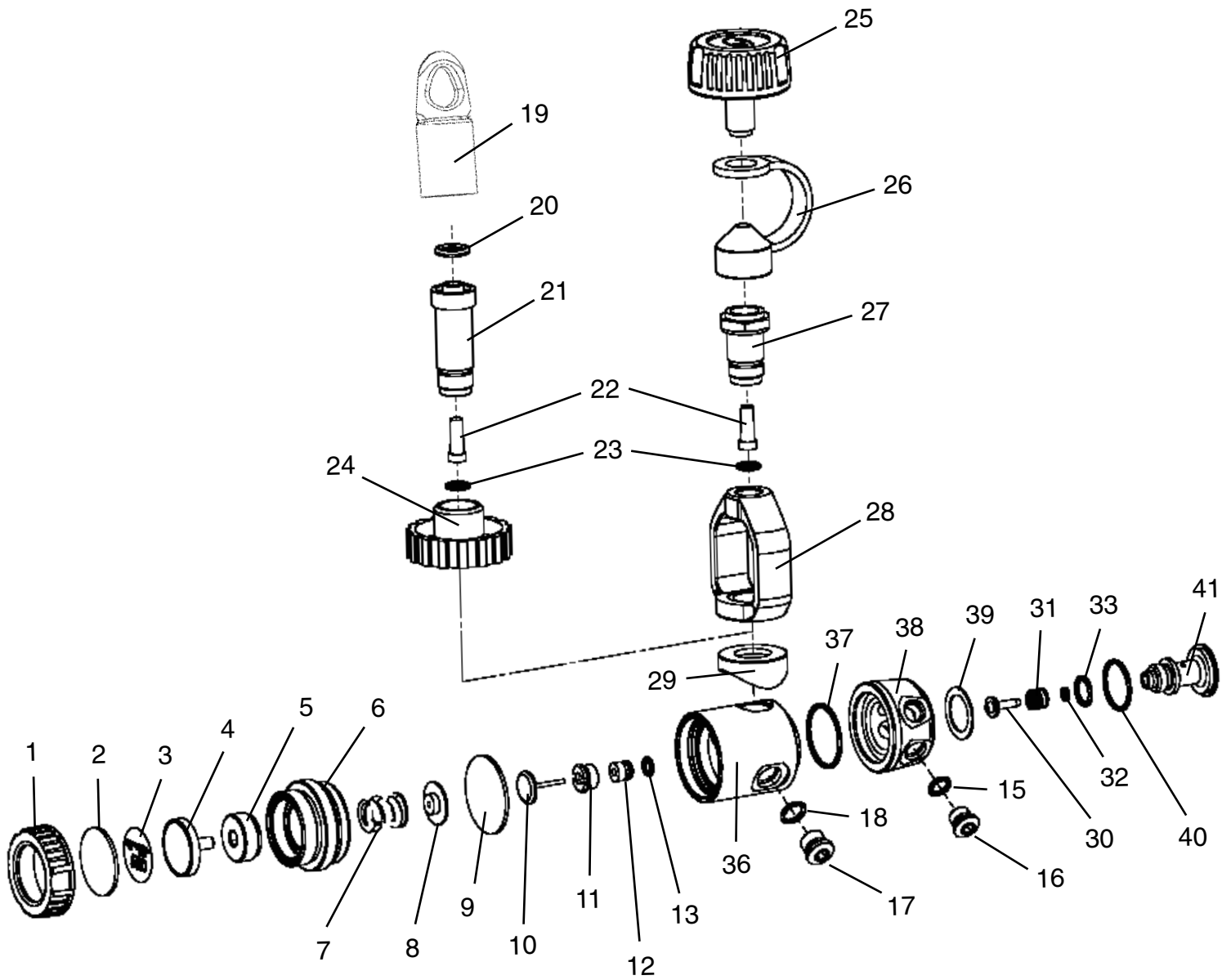

Go to next page for Item Numbers.

**50D First Stage Assembly**  
**Yoke Model: 310-2110**  
**DIN Model: 310-2120**

1	341-0118-SA	Environmental End Cap
2*	341-0121-MC	Hydrostatic Diaphragm (clear)
3	341-0144-AA	Label (specify model to customer service)
4	341-0119-KA	Hydro-Transmitter
5	341-0103-CD	Spring Adjuster
6	341-0122-CD	Diaphragm Clamp
7	341-0140-VH	Regulating Spring
8	341-0104-CD	Spring Carrier
9*	341-0105-TA	Internal Diaphragm (black)
10	341-0106-VH	Lifter
11	341-0109-CD	Seat Support
12*	341-0108-JA	Seat (orifice)
13*	160-0009-N9	O-ring (for seat)
14	341-0101-CL	Body, Satin Finish (for DS-IV, non-swivel style 1st stage)
15*	160-0011-N7	O-ring (for LP port plugs)
16	341-0127-CD	LP Port Plug (includes O-ring)
17	341-0128-CD	HP Port Plug (includes O-ring)
18*	160-0012-N9	O-ring (for HP port plugs)
19	341-0129-AA	DIN Cap
20*	160-0111-N7	O-ring (for inlet of DIN bolt)
21	341-0112-CD	Din Connector Bolt
22*	341-0139-BA	Conical Filter
23*	160-0011-N7	O-ring (for filter & bolt)
24	341-0142-AA	DIN Wheel
25	341-0115-AA	Yoke Knob Assembly
26	341-0117-LA	Dust Cap
27	341-0111-CD	Yoke Bolt
28	341-0113-DL	Yoke, Satin Finish
29	341-0116-KA	Spacer
30	341-0107-VH	HP (high pressure) Valve
31	341-0141-VA	Valve Spring
32*	160-0006-N7	O-ring (smallest O-ring in HP balance plug)
33*	160-0905-N9	O-ring (middle sized O-ring on HP balance plug)
34*	160-0016-N7	O-ring (largest sized O-ring on HP balance plug)
35	341-0110-CD	HP Balance Plug
36	341-0123-CL	Body, Satin Finish (for 50D, swivel style 1st stage)
37*	160-0024-N7	O-ring (for 50D body to turret)
38	341-0124-CL	Turret, Satin Finish
39	341-0125-GA	Thrust Washer
40	160-0019-N7	O-ring (for turret to turret bolt)
41	341-0120-CD	Turret Bolt

\* An asterisk next to the Item Number means that part is included in the Standard Service Kit. The Service Kit Part # for the 1st Stage is 345-1000. The 2nd Stage Service Kit Part # is 345-2000.

**IMPORTANT:** Items 14, 28, 36, and 38 had a shiny chrome finish in early models rather than the current satin chrome finish. If you want to order these parts in a shiny chrome finish instead of satin, change the last letter in the part number from "L" to "D". These parts in a shiny chrome finish will be subject to availability.

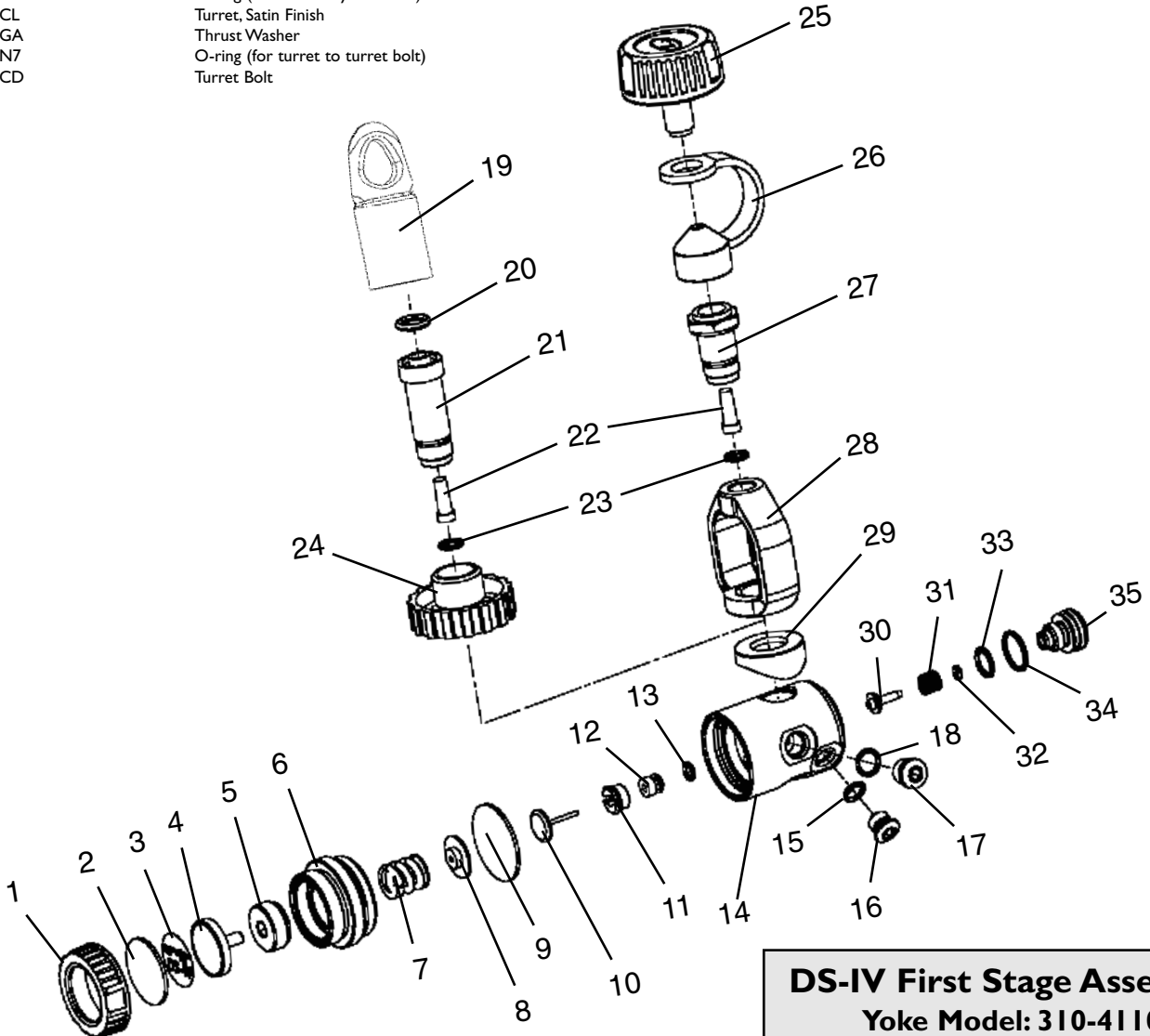

**DS-IV First Stage Assembly**  
**Yoke Model: 310-4110**  
**DIN Model: 310-4120**

## TABLE OF CONTENTS

- 1.0 Introduction
  
- 2.0 Specifications
  - 2.1 Torque Specifications
  - 2.2 Model Numbers
  
- 3.0 O-rings Reference Chart
  
- 4.0 First Stage Procedures
  - 4.1 Tools Required for First Stage Servicing
  - 4.2 Disassembly of the First Stage
  - 4.3 Cleaning and Inspection of the First Stage
  - 4.4 Preliminary Assembly of the First Stage
  - 4.5 Set-up and Testing of the First Stage
  - 4.6 Final Assembly of the First Stage
  
- 5.0 ZX Second Stage Service Procedures
  - 5.1 Tools Required for Second Stage Servicing
  - 5.2 Disassembly of the Second Stage
  - 5.3 Cleaning and Inspection of the Second Stage
  - 5.4 Preliminary Assembly of the Second Stage
  - 5.5 Set-up of the Second Stage
  - 5.6 Final Assembly of the Second Stage
  - 5.7 Testing of the Second Stage
  
- 6.0 Helpful Hints
  - 6.1 Troubleshooting
  - 6.2 Parts Cleaning Recommendations
  - 6.3 Commonly Used Cleaning Solutions
  - 6.4 Handling Tips
  
- 7.0 Warranty and Maintenance Information
  - 7.1 Proper Procedure for Warranty Paperwork
  - 7.2 Scheduled Maintenance
  - 7.3 Order Form (sample)

### **Before You Begin .....**

Read these instructions completely before you begin servicing the regulator. These instructions are intended for people who have been AUTHORIZED by Zeagle to repair Zeagle Scuba equipment. If you are not so authorized - STOP.

### **FIRST STAGE**

The letter at the beginning of the serial number on the first stage indicates the model of that first stage. If the serial number begins with "A" it is a DS-IV non-swivel first stage (e.g.A001324). If the serial number begins with "B" it is a 50D swivel turret first stage. If the serial number begins with "F" it is a Flathead VI first stage. For further information, contact Zeagle.

## 1.0 INTRODUCTION

1.1 The procedures in this manual apply to Zeagle Scuba Regulators. There are two front cover fold outs inside containing exploded views of the first stages. The one you fold out depends on which model you are servicing. One foldout is for the Flathead-VI first stage. The other is for the 50D (swivel) and DS-IV (non-swivel) model. If you are not sure which first stage you are working on, refer to the pictures on the front of this manual. Refer to the exploded view as you read the service section of the manual. The Item Numbers referred to in the service section are those seen in the exploded view.

### **WARNING**

NEVER reuse the diaphragm in the first stage. A used diaphragm will not clamp securely as required. A used diaphragm may come loose during use, causing a severe regulator malfunction. This is true with all diaphragm first stages. Failure to read this warning may result in serious injury or death.

NEVER tighten the hose fitting to the first stage with more than 40 in. lbs. (4.5 Nm) of torque. The inlet hose fitting will be weakened by over tightening. Failure to read this warning may result in serious injury or death.

**NOTE:** All Zeagle Scuba Regulators have service kits available which contain the parts which must be changed at every annual service no matter what their condition. The standard annual service kit part numbers are shown in the parts list. All other parts not contained in these kits must be inspected by the technician and changed under warranty only if they have failed due to problems with material or workmanship.

### **WARNING**

Zeagle Scuba Regulators are manufactured using materials suitable for use with oxygen enriched gases (i.e. Nitrox, etc.) providing the oxygen content does not exceed 40%. Equipment intended for enriched air (Nitrox) use must not be used with regular compressed breathing air, or other gases. Regulators intended for enriched air use can be serviced only by technicians trained by one of the major oxygen enriched air training agencies. Failure to heed this warning may result in serious injury or death.

1.2 This manual gives breakdowns of regulator parts, equipment specifications, servicing instructions, troubleshooting recommendations, and guidelines for proper care of Zeagle regulators. This manual is intended for use only by persons specially trained and authorized to service Zeagle Scuba equipment.

1.3 Anyone attempting to service or repair Zeagle Scuba regulators must have a thorough understanding of the principles of operation of scuba regulators and valves, as well as the appropriate mechanical ability. The technician must be properly trained in the safe use of compressed air and the various tools and cleaning solutions involved in the procedures outlined in this manual.

1.4 The best source for current part numbers for any of the parts listed in this manual is your current parts and price list from Zeagle.

1.5 Zeagle conducts seminars on a regular basis to train technicians in proper service and repair procedures for all current Zeagle regulators. In addition, all Zeagle dealers and their staff members are encouraged to attend the seminars to gain an in-depth understanding of the construction, special features and operation of Zeagle regulators. For information on the dates and locations of upcoming Zeagle service seminars near you, contact Zeagle or a Zeagle Sales Representative.

**NOTE:** You must be authorized by Zeagle to work on Zeagle Scuba equipment. You can obtain proper authorization by attending all appropriate seminars given in your area. This is the only way you can become an authorized Zeagle technician.

1.6 If you have any questions, or need more information, contact your Zeagle Scuba Sales Representative or Zeagle Customer Service. You can E-mail your technical questions to [info@zeagle.com](mailto:info@zeagle.com)

## 2.0 SPECIFICATIONS

Zeagle Models ZX Flathead-VI, ZX 50D and ZX DS-IV

AIR FLOW .....	33 cu. ft. (935 liters)/min. @ 1 atmosphere
INHALATION RESISTANCE .....	0.9" -2.0" (2.3 - 5.08 cm) w.c. @ 1 atmosphere (adjustable)
EXHALATION RESISTANCE .....	0.6" (1.52 cm) w.c. max. @ 1 atm.
RECOMMENDED LUBRICANT	LTI Christo-Lube 111®

### A. FIRST STAGE REGULATORS 50D (swivel), DS-IV (non-swivel)

TYPE	Balanced Diaphragm, Dry Environmental Seal with Hydrostatic Transmitter
WEIGHT .....	DS-IV 1.9 lb. (.86 kg) 50D 2.1 lb. (.95 kg) Flathead-VI 2.1 lb. (.99 kg.)
INTERSTAGE PRESSURE .....	130-145 psi (9-10 bar)(135 psi / 9.3 bar, nominal)
# LOW PRESSURE PORTS .....	4 (3/8"-24 UNF)
# HIGH PRESSURE PORTS .....	2 (7/16"-20 UNF)
MATERIALS .....	Body ----- CDA-360 Brass O-rings ----- Buna-N Seat ----- Advanced Polymer HP Valve --- Stainless Steel

### B. ZX 2nd STAGE REGULATOR

TYPE .....	Downstream valve, balanced diaphragm, Diver Adjustable Dive / Pre-Dive Venturi Lever and Resistance Control Knob
WEIGHT.....	.26 lb. (.54 kg) ( w/o hose )
HOSE LENGTH .....	30 in. (76 mm)
MATERIALS .....	Cover ----- Flexible Thermoplastic Case ----- Rigid Thermoplastic Poppet Seat ----- Advanced Elastomer O-rings ----- Buna-N Diaphragm ----- Elastomeric Polymer Exhaust Valve----- Thermoplastic Elastomer Mouthpiece ----- Silicone

## 2.1 Torque Specifications:

Description	Item #	Torque
Environmental End Cap	1	Hard hand tight (with rag cushioning hand)
Diaphragm Clamp	6	25-30 ft/lb (34-40 Nm) (with pin spanner)
DIN Bolt	21	20-25 ft/lb (27-34 Nm) (with 1/4" Allen wrench)
Yoke Bolt	27	20-25 ft/lb (27-34 Nm)
HP Balance Plug	35	2-3 ft/lb (3-4 Nm) (with 1/4" Allen wrench)
Turret Bolt	41	2-3 ft/lb (3-4 Nm) (with 1/4" Allen wrench)
Seat Support	11	snug metal contact (with 3/16" Allen wrench)
Port Plugs	16, 17	2-3 ft/lb (3-4 Nm) (with 5/32" Allen wrench)
Hose inlet end	30	2-3 ft/lb (3-4 Nm)
Hose outlet end	30	2-3 ft/lb (3-4 Nm)
2nd Stage Nut	7	1-2 ft/lb (2-3 Nm)







## 2.2 Model Numbers:

Model #	Description
---------	-------------

350-1110	Flathead-VI Yoke 1st Stage, with ZX 2nd Stage - 30" Hose
350-1121	Flathead-VI DIN 1st Stage, with ZX 2nd Stage - 30" Hose + DIN to Yoke Converter
350-2110	50D (swivel turret) Yoke 1st Stage with ZX 2nd Stage - 30" Hose
350-2121	50D (swivel turret) DIN 1st Stage with ZX 2nd Stage - 30" Hose + DIN/Yoke Converter
350-4110	DS-IV (non-swivel) Yoke 1st Stage with ZX 2nd Stage - 30" Hose
350-4121	DS-IV (non-swivel) DIN 1st Stage with ZX 2nd Stage - 30" Hose + DIN/Yoke Converter
320-1110	2nd Stage only, ZX Octopus 2nd Stage with Yellow Cover - 36" Hose
320-1115	2nd Stage only, ZX Standard 2nd Stage with Gray Cover - 30" Hose
310-1110	1st Stage only, Flathead-VI Yoke
310-1120	1st Stage only, Flathead-VI DIN
310-2110	1st Stage only, 50D (swivel turret), Yoke
310-2120	1st Stage only, 50D (swivel turret), DIN
310-4110	1st Stage only, DS-IV (non-swivel) Yoke 1st Stage
310-4120	1st Stage only, DS-IV (non-swivel) DIN 1st Stage
330-0001	DIN to Yoke Converter (allows a DIN equipped regulator to be mounted on a Yoke Valve with no tools.)

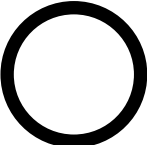
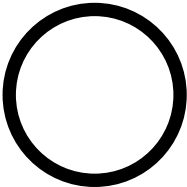
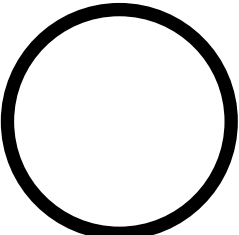

## Ist Stage O- Rings (included in Kit) # 345-1000

-  ————— **160-0006-N7 (32) for stem of HP Valve (30)**
-  ————— **160-0009-N9 (13) for seat (Orifice) (13)**
-  — **160-0011-N7 (15, 23) for LP ports (3) & inlet filter (1)**
-  ————— **160-0012-N9 (18) for HP ports (2)**
-  ————— **160-0905-N9 (33) behind thread of HP balance plug (35)**
-  ————— **160-0111-N7 (20) for inlet end of DIN bolt (21)**
-  ————— **160-0016-N7 (34) for large end of HP balance plug (35)**
-  ————— **160-0019-N7 (40) for turret to turret-bolt seal**
-  ————— **160-0024-N7 (37) for turret to body seal**

## **4.0 SERVICE PROCEDURES FOR THE ZEAGLE MODEL DS-IV (non-swivel) and 50D (swivel-turret) and Flathead-VI (hi-flow) 1st STAGES**

4.0.1 Before you begin disassembly of the regulator, test the first and second stages for output pressures and leakage. Pre-testing in this way will help the technician to pinpoint any specific problems requiring repair.

4.0.2 The work area must be clean and well lighted, with clean compressed air available to blow sand and dirt from parts.

### **4.1 TOOLS & ITEMS REQUIRED FOR FIRST STAGE SERVICING**

- Soft-jawed bench vise (bench vise with rubber, plastic, aluminum or plastic jaw inserts)
- 1/4" Allen wrench (p/n 347-0104)
- 3/16" Allen wrench (p/n 347-0316)
- 5/32" Allen wrench (p/n 347-0532)
- 6" or 8" good quality adjustable wrenches
- 15" good quality adjustable wrench
- Zeagle Pin Spanner (p/n 347-0001)
- 1st Stage Annual Service Kit (p/n 345-1000)
- Clean Shop Rags
- LTI Christo-Lube III® (p/n 347-0111)
- Service Video Tape for this regulator (p/n 347-0101)
- Intermediate Pressure Testing Gauge

### **4.2 DISASSEMBLY OF THE FIRST STAGE FOR OVERHAUL**

To view all of the parts used in the Flathead-VI (hi-flow), 50D (swivel turret), or DS-IV (non-swivel) first stage, fold out the first page of this manual and view the exploded view appropriate for the model you are working on. The bracketed numbers in the text refer to the corresponding circled item numbers on the exploded view drawing.

4.2.1 Use 6" or 8" adjustable wrenches to disconnect all hoses from the first stage. Pull back the hose protector from the inlet end of the hose. Inspect the hoses for wear. Pay particular attention to the area where the metal ferrules meet the rubber hose material. Remove and discard the O-rings from each end of the hose. Clean, rinse, and blow-dry the interior bores of the hoses. Replace the hoses if necessary.

4.2.2 Unscrew and remove the environmental end cap (1).

4.2.3 Remove and discard the clear silicone hydrostatic diaphragm (2).  
Remove the black hydro-transmitter (4).

**Note:** The three first stage models covered in this section vary slightly. The minor service procedure differences are covered. If the regulator you are working on is a 50D (swivel-turret type) skip to instruction 4.2.5. If it is a Flathead-VI (hi-flow) or DS-IV (non-swivel type) continue to the next step listed. See the pictures on the front cover of this manual if you are not sure which type you have.

4.2.4 **Note:** For Flathead-VI and DS-IV non-swivel only. Clamp the regulator carefully in a soft-jawed vise with the HP balance plug (35) facing up. Position the regulator so that the yoke (28) or DIN wheel (24) is preventing the regulator from rotating as the HP balance plug is loosened. Use a 1/4" Allen wrench to loosen and remove the HP balance plug assembly (30, 31, 32, 33, 34, and 35) from the body (14). See Photo #1. Now skip to step 4.2.6

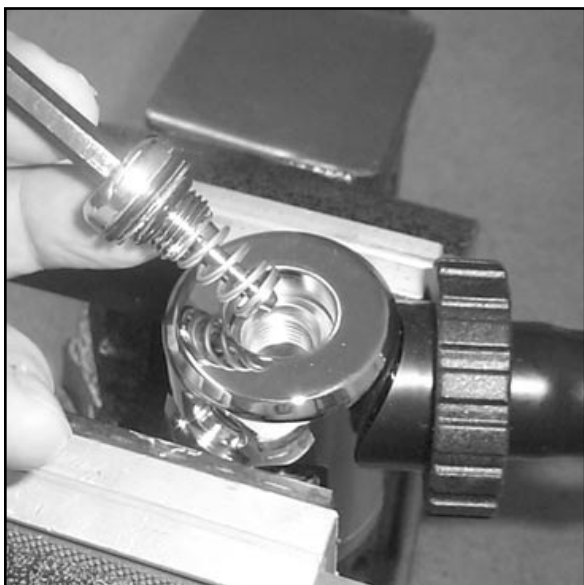

**Photo 1** HP Balance Plug Assembly removal  
Flathead-VI or DS-IV (DS-IV shown)



**Photo 2** Turret Bolt Assembly removal  
(50D only)

4.2.5 **Note:** This step is for the 50D swivel model only. Clamp the regulator carefully in a soft-jawed vise with the turret bolt (41) facing up. Position the regulator so that the yoke (28) or DIN wheel (24) is preventing the regulator from rotating as the turret bolt is loosened. Use a 1/4" Allen wrench to loosen and remove the turret bolt assembly (30, 31, 32, 33, 40 and 41) from the turret (38). See Photo #2. Remove the turret assembly (37, 38, 39) from the body (36).

4.2.6 If the regulator has severe internal corrosion (due to salt water being forced through the inlet filter), it may be necessary to carefully use a pair of pliers to remove the HP valve (30) from the HP balance plug (35) or turret bolt (41). If so, pull the valve out straight and slowly, taking care not to bend the stem of the HP valve. Remove and discard all O-rings.

4.2.7 Re-clamp the regulator carefully in a soft-jawed vise with the diaphragm clamping ring (6) facing up. Position the regulator so that the yoke (28) or DIN wheel (24) is preventing the regulator from rotating as the diaphragm clamping ring is loosened.

4.2.8 Use a Zeagle pin spanner (p/n 347-0001) installed in the hole in the diaphragm clamping ring (6) to loosen and remove the diaphragm clamping ring from the body (14 or 36). See photo #3. The heel of the spanner can be wrapped in tape to help prevent damage to the chrome finish on the clamping ring.



**Photo 3**  
(50D shown)

4.2.9 Remove the body assembly from the vise.

4.2.10 Use a 1/4" Allen wrench to remove the spring adjuster (5) from the diaphragm clamping ring (6). Remove the spring (7), spring carrier (8), diaphragm (9) and lifter (10) from the body (14 or 36). Discard the diaphragm (9).



## **WARNING**

NEVER reuse the diaphragm in the first stage. A used diaphragm will not clamp securely as required. A used diaphragm may come loose during use, causing a severe regulator malfunction. This is true with all diaphragm first stages. Failure to read this warning may result in serious injury or death.

4.2.11 Use a 3/16" Allen wrench to remove the seat support (11) from the body.

4.2.12 Remove the seat (12), the seat O-ring (13) and discard both.

4.2.13 Re-clamp the body carefully in a soft-jawed bench vise. Use a 10" adjustable wrench to loosen and remove the yoke bolt (27) and spacer (29). See Photo # 4. Remove the yoke knob assembly (25) and the dust cap (26) from the yoke (28).

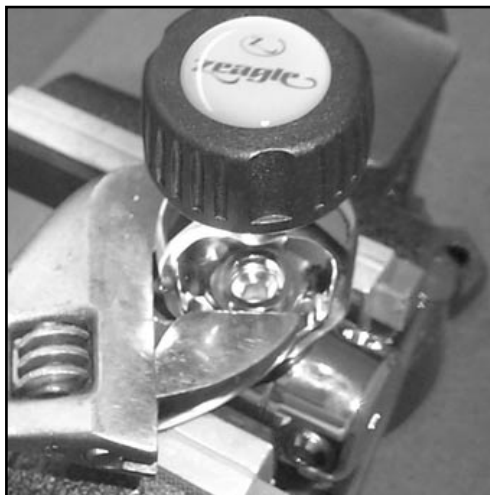

**Note:** If the regulator has a DIN wheel, use a 1/4" Allen wrench to remove the DIN bolt (21), and DIN wheel (24). The Flathead-VI also has a spacing washer (45) behind the DIN wheel.

4.2.14 Remove and discard the inlet filter (22), the filter O-ring (23) and the DIN inlet O-ring (20) if the regulator is DIN equipped.

4.2.15 Using a 5/32" Allen wrench, remove all remaining port plugs (16, 17) from the body (14 or 36). Discard the port plug O-rings (15, 18).

### 4.3 Cleaning and Inspection of the 1st Stage

4.3.1 Clean all metal parts of the first stage in an ultrasonic cleaner or cleaning solution. See Section 6.3 for recommendations on cleaning solutions. Remove the O-rings before cleaning any metal parts since the soft O-ring material will absorb cleaning energy from the ultrasonic cleaner reducing its effectiveness. If major visible corrosion or deposits exist on parts, use a bristle brush, wooden, or plastic stick to rub the deposits off. Allowing acidic cleaning solutions to do all of the work if deposits are severe, will result in damage to internal chrome plating which will make parts even more susceptible to future corrosion.

4.3.2 Remove the regulator parts from the cleaning solution rinse and blow internal passageways dry with clean, dry compressed air.

4.3.3 Inspect the diaphragm sealing surfaces and O-ring grooves for scratches or wear. If the regulator was leaking air because of scratches or wear, replace the parts. If some corrosion deposits persist, carefully wipe them away with a plastic scrubbing cloth. Blow any resulting dust out of the regulator parts.

4.3.4 Roll the stem of the lifter (10) along the square edge of a table or similar surface to check the stem for straightness. If the head of the lifter wobbles as the stem is rotated, the lifter must be replaced. The most common cause of lifter stem bending is assembling the regulator in the wrong order. (See 4.4)

### 4.4 PRELIMINARY ASSEMBLY OF THE FIRST STAGE

**Correct order of assembly is extremely important! The diaphragm end MUST be assembled before the HP balance plug end. Incorrect assembly order will result in damage to the first stage lifter (10) and seat (12). If the diaphragm end of the regulator is opened for any reason, such as replacing the HP seat (12), the other end of the regulator (turret or HP balance plug) MUST BE DISASSEMBLED so that the diaphragm end can be re-assembled first.**

To determine the identity of each O-ring in the 1st Stage Service Kit, remove them from the bag and use the O-ring Identification Chart on the front page of this manual. Lay each O-ring over its corresponding picture on the page and read the description. Before installing new O-rings into the regulator, lightly lubricate the O-rings with LTI Christo-Lube III®. The most effective way to lubricate the kit O-rings is to put them in a small plastic bag with a pea sized amount of LTI Christo-Lube III®. Rub the O-rings and grease together in the bag until all the O-rings are coated evenly. Try not to wipe the lubrication off the O-rings when assembling them onto other parts.

- 4.4.1 Install the yoke bolt (27) into the yoke (28).
- 4.4.2 Install the spacer (29) onto the yoke bolt (27).
- 4.4.3 Install the new inlet filter (22) and filter O-ring (23) into the yoke bolt (27).
- 4.4.4 Hand tighten the yoke, yoke bolt, and spacer into the body (14 or 36).
- 4.4.5 **Note:** If the regulator has a DIN connection, install the DIN bolt (21) with a new O-ring (20), DIN wheel (24) and spacer (29) into the body as described for the yoke assembly. If the regulator is a Flathead-VI, also install the spacer washer (45)
- 4.4.6 Place the body (14 or 36 or 42) carefully into a soft-jawed vise so that the yoke bolt or DIN bolt is facing up.
- 4.4.7 Tighten the yoke bolt with a 10" adjustable wrench, or the DIN bolt with a 1/4" Allen wrench. Tighten to 20-25 ft/lb (27-34 Nm)
- 4.4.8 Re-position the body in the soft-jawed vise until the diaphragm opening faces up. Position the body so that the yoke or DIN wheel will prevent the body from turning as you tighten the parts (clockwise).
- 4.4.9 Install the lightly lubricated O-ring (13) onto the seat (12).
- 4.4.10 Install the seat (12) into the body (14 or 36) from the diaphragm end. The seat installs with the end with the notch and O-ring groove towards the body.
- 4.4.11 Use a 3/16" Allen wrench to install the seat support (11) over the seat. Tighten the seat support until you feel it make full contact with the body. Do not tighten beyond that point.
- 4.4.12 Install the lifter (10) into the seat support.
- 4.4.13 Install the new diaphragm (9) into the body.

 **WARNING**

NEVER reuse the diaphragm in the first stage. A used diaphragm will not clamp securely as required. A used diaphragm may come loose during use, causing a severe regulator malfunction. This is true with all diaphragm first stages. Failure to read this warning may result in serious injury or death.

- 4.4.14 Place the spring carrier (8) onto the center of the diaphragm.
- 4.4.15 Place the main spring (7) onto the spring carrier (8).
- 4.4.16 Screw the spring adjuster (5) about two turns into the diaphragm clamping ring (6) (from the outside end of the diaphragm clamping ring).
- 4.4.17 Place the diaphragm clamping ring over the top of the main spring (7) carefully to avoid pushing the spring and spring carrier out of position on the center of the diaphragm. Tighten the ring down by hand as far as possible.

Use the pin spanner wrench (Zeagle p/n 347-0001) to tighten the diaphragm clamping ring the rest of the way down. Tighten to 25-30 ft/lb (34-40 Nm) torque or until the edge of the diaphragm clamping ring and the body meet metal to metal. **This is essential to ensure that the diaphragm is securely clamped.** Use an old 1st Stage diaphragm as a cushion under the spanner to prevent marks from being made on the diaphragm clamping ring.

4.4.18 Turn the body over carefully and re-clip it in the soft-jawed vise so that the turret or HP balance plug end (depending on model) is faced up.

4.4.19 **Note: Steps 4.4.20 to 4.4.24 are for the 50D (swivel) model only. Skip to step 4.4.25 if you are working on a DS-IV (non-swivel).** Lightly lubricate the new O-rings from the annual service kit with LTI Christo-Lube III®. Install O-ring (37) onto the body (36). Install O-rings (32, 33, and 40) onto the turret bolt (41).

4.4.20 Lightly lubricate the stem of the HP valve (30). Snap the end of the spring (31) over the ledge on the HP valve. Insert the valve and spring into the turret bolt (41).

4.4.21 Install the turret (38) onto the body (36). Re-lubricate the cleaned white thrust washer (39) and install it into the turret (38).

4.4.22 Install the turret bolt and valve assembly onto the end of the regulator. Take care to insure that the HP valve (30) fits over the stem of the lifter (10) as you install the assembly into the body.

4.4.23 Screw the turret bolt assembly into the body with a 1/4" Allen wrench. Tighten to 2-3 ft/lb (3-4 Nm) torque or just until you feel firm metal to metal contact stopping the rotation of the parts. **Now skip to step 4.4.30**

4.4.24 **Note: This and following steps 4.4.26 to 4.4.29 are for the Flathead-VI (hi-flow) and DS-IV (non-swivel) model only.** Lightly lubricate the new O-rings from the annual service kit with LTI Christo-Lube III® and install them onto the HP balance plug (35).

4.4.25 Lightly lubricate the stem of the HP valve (30). Snap the end of the spring (31) over the ledge on the HP valve.

4.4.26 Insert the valve and spring into the HP balance plug (35).

4.4.27 Install the HP balance plug and valve assembly onto the end of the regulator. Take care to insure that the HP valve (30) fits over the stem of the lifter (10) as you install the assembly into the body.

4.4.28 Screw the HP balance plug into the body with a 1/4" Allen wrench. Tighten to 2-3 ft/lb (3-4 Nm) torque or just until you feel firm metal to metal contact stopping the rotation of the parts.

4.4.29 Install the dust cap (26) and yoke knob (25) onto the yoke.

4.4.30 Install new O-rings (15, 18) from the kit onto port plugs (16,17) and install the port plugs into the appropriate ports.

## 4.5 SET-UP AND TESTING OF THE FIRST STAGE

**NOTE:** For safety, always test the first stage regulator with at least one second stage installed. The demand valve on the second stage acts as a relief valve in case of a malfunction.

4.5.1 Install an intermediate pressure test gauge into one of the low-pressure ports of the first stage, and a functional 2nd stage into another low pressure port. Plug any remaining open outlet ports with suitable port plugs.

**NOTE:** The following test determines the regulator's lock-up pressure (the pressure put out by the first stage during a no flow condition).

4.5.2 Attach the regulator to a tank valve giving a source pressure of between 2700 and 3500 psig (186-240 Bar).

4.5.3 Turn the supply air on slowly while listening for any unusual air leaks. If any are heard, turn the air off immediately and determine the source of the leak. If no leaks are found, watch the intermediate pressure gauge reading rise as you continue turning the air on slowly. It should stop before 145 psig (10 bar) since the intermediate pressure has not been set yet.

4.5.4 If the pressure gauge continues to rise above 155 psig (10.4 bar), turn the air supply off immediately and inspect the regulator to determine the cause.

4.5.5 Depress the purge cover fully, then release it several times to clear particles from the regulator, and to work the internal parts into place. To prevent uncontrolled free flows after pushing the purge cover, keep the venturi control lever on the second stage in the "-"(negative position)

4.5.6 The pressure range for Zeagle Regulators is 130-145 psi( 9-10 bar) Use a 1/4" Allen wrench installed into the spring adjuster (5) to change the intermediate pressure. Turn the spring adjuster clockwise in 1/8-turn steps to raise the intermediate pressure, and counter clockwise in 1/8 - turn steps to lower it. See Photo # 5. Always push the purge cover briefly between each adjustment step. Do not push on the diaphragm with the tip of the Allen wrench, or a false (higher) reading will occur. The optimal intermediate pressure for Zeagle regulators is 135 psi (9.3 bar), but any setting between 130 and 145 psi (9-10 bar) will provide good stable performance..





4.5.7 After reaching the proper pressure setting, push the purge cover on the second stage again several times and watch how the intermediate pressure reading responds. When the purge cover on the second stage is depressed, the intermediate pressure reading will drop. When the purge cover is released the pressure should return immediately to the proper lock-up pressure and stay there.

4.5.8 Let the regulator sit with the tank valve turned on for several minutes. The intermediate pressure reading may rise about 3 psi in the first three seconds after lock-up, but after that it should not rise more than another 4 psi (.3 bar) in five minutes. If it rises more than 4 psi refer to the Trouble-shooting Section 6.1 of this manual.

**Note:** Never set the output pressure of the first stage above 145 psi (10 bar).

## 4.6 FINAL ASSEMBLY OF THE FIRST STAGE

4.6.1 To finish installing the end cap on the first stage, the pressure to the first stage must be left on to position all internal parts properly.

4.6.2 With the regulator pressurized, insert the hydro transmitter (4) into the body assembly.

4.6.3 Install the new clear hydrostatic diaphragm (2) into the recess in the diaphragm clamping ring (6) over the hydro transmitter. On the Flathead-VI only, install the trim ring (44).

4.6.4 Install the end cap (1) onto the diaphragm clamping ring (6). Use a clean rag to help grasp the end cap. Tighten the end cap firmly. Use enough force so that the end cap cannot be loosened easily by hand. On the Flathead-VI only, use the Zeagle Pin Spanner (347-0001) to tighten the cap snugly. Use an old 1st Stage diaphragm as a cushion under the spanner to prevent marks from being made on the environmental end cap.

4.6.5 Push the clear hydrostatic diaphragm (2) briefly with one finger while watching the intermediate pressure gauge. The pressure should rise about 1 psi for every pound of force. For example, five or ten psi (.35 - .7 bar) increase in intermediate pressure when the diaphragm is pushed with five or ten pounds.

4.6.6 Turn off the supply pressure and depress the purge cover to release the air from the second stage. When the intermediate pressure drops to zero you should see the clear hydrostatic diaphragm (2) pull into the body assembly. If the regulator is re-pressurized, the clear diaphragm will push out to the flat position. If (by mistake) the end cap (1) is loosened and then re-tightened without pressure applied to the first stage, the clear diaphragm will bulge outwards when the regulator is under pressure. If this condition exists, follow steps 4.6.1 to 4.6.5.

## 5.0 ZX SECOND STAGE SERVICE PROCEDURES

The procedures covered in this manual section apply to the ZX second stage. To access the exploded view of this model, fold out the back page of this section of the manual. This second stage is used as a primary unit, gray or black purge cover and 30" hose (model assembly number 320-1115) and as an advanced octopus unit, yellow purge cover and 36" hose (model assembly number 320-1110). See the picture on the front page of this manual section to identify this model type. The serial number for this model always starts with "H". The number can be seen by curling back the mouthpiece and looking at the end of the mouth-tube.

### 5.1 TOOLS REQUIRED FOR SECOND STAGE SERVICING

- Two good quality 6" or 8" (15 or 20 cm) adjustable wrenches
- Side cutting pliers
- 3/16" Allen Wrench (p/n 347-0316)
- 2nd Stage, Inline Adjusting Tool - 3/16" Hex (p/n 347-0002)
- 2nd Stage Annual Service Kit (p/n 345-2000)
- Clean Shop Rags
- LTI Christo-Lube 111® (p/n 347-0111)
- Service Video Tape for this regulator (p/n 347-0101)

### 5.2 DISASSEMBLY OF THE SECOND STAGE



#### WARNING

NEVER tighten the hose fitting to the first stage with more than 40 in. lbs. (4.5 Nm) of torque. The inlet hose fitting can be weakened by over tightening.

To view the complete parts list of the second stage, fold out the back cover of this manual.

5.2.1 Pull the nut cover (6) off of the nut (7). Use the 6" and 8" adjustable wrenches to loosen the hose nut from the valve tube (21). Remove the hose assembly (30) from the second stage. Inspect the hose assembly for any cuts or cracks, especially on the hose at the metal ferrules. Remove and discard the O-rings from each end of the hose. Clean, rinse, and blow-dry the interior bores of the hoses. Replace the hose assembly if any cuts or cracks are found.

5.2.2 Remove the mouthpiece (12) by cutting the two mouthpiece ties (11) with side cutting pliers. Discard the old mouthpiece ties. Examine the condition of the mouthpiece. Pay particular attention to the area on top just behind where the old ties tightened. This is a prime area for small holes to develop. If the mouthpiece is in good condition, it can be reused.

5.2.3 Remove the exhaust tee (13) from the case by pulling it back and off the top edge of the retaining flange on the housing. **Note:** The exhaust tee can be removed more easily if hot water from a tap is run over and through it for about one minute.

5.2.4 Before removing the exhaust valve (14) from the housing (10), bend the valve over as far as it will go from the top, bottom, left, and right sides. If it fails to snap back quickly, and does not lie perfectly flat against the housing exhaust grid, the valve should be replaced. If it does snap back satisfactorily, remove it by pulling it out with your fingers. Inspect the sealing edges. If they appear smooth, and the locking tab on the nipple is good, the valve can be reused.

5.2.5 Unscrew the cover ring (1) from the housing (10).

5.2.6 Remove the diaphragm cover (3) and diaphragm (4) from the housing (10).

5.2.7 For future reference, look at the lever (19) at this time. Notice how the pivot end of the lever is held into the valve tube (21) by two plastic flanges on the housing. Note this positioning for re-assembly.

5.2.8 Hold the diaphragm up to a light source. Gently stretch the diaphragm and look for tears or pinholes. If any are found, replace the diaphragm.

5.2.9 Loosen and remove the nut (7) from the valve tube (21)

5.2.10 Remove the heat sink (8) from the valve tube. **Note:** On some models instead of a metal heat sink, there is a plastic bushing (34).

5.2.11 Remove and discard the O-ring (9) from the valve tube.

5.2.12 Turn the spring adjust knob (29) fully counter clockwise until it comes to its stop.

5.2.13 Depress the lever (19) fully onto the valve tube. Grasp the tab of the venturi control lever (16). While pulling on the venturi control lever, push the valve tube assembly out of the housing (10).

5.2.14 Remove the venturi control lever (16) from the valve tube assembly. Remove and discard the O-ring (15) from the venturi control lever.

5.2.15 Turn the spring adjust knob (29) clockwise 1/2 turn. The pin (20) will fall out of the valve tube or can now be easily removed.

5.2.16 Turn the spring adjust knob assembly (29) counter clockwise to remove it from the valve tube. Remove and discard the O-ring (28). **Note:** On some models there is a plastic spring adjuster plug (35) instead of an adjust knob assembly. Use a 1/4" Allen wrench to remove it.

5.2.17 The balancing chamber (26), spring (25) and piston (23) are removed at this time. They will often fall out if the valve tube is tipped on its end. If the piston will not fall out, the lever (19) can be moved through its full arc. If the piston still does not come out a 5/32" (4-5 mm) Allen wrench can be inserted through the male threaded end of the valve tube, through the seat (18) to gently push the piston out.

5.2.18 Remove and discard the O-ring (27) from the outside of the valve tube (21).

5.2.19 The lever (19) should not be removed from the valve tube unnecessarily. However, it can be removed from the valve body by carefully springing out one of the feet and pivoting it over the valve tube body. Do not over-bend the lever legs. Straighten the legs if they are bent outward from parallel.

5.2.20 Remove and discard the seating seal (22) from the piston (23).

5.2.21 Remove and discard the very small O-ring (24) from the piston. This can be done by pinching a section of the O-ring out of the groove with the fingernails. Then flip the O-ring off the end of the piston stem. **DO NOT USE SHARP METAL PICKS!** Metal tools will damage the O-ring groove, which will cause a small continuous second stage leak.

5.2.22 Use a 3/16" Allen wrench or the Zeagle 2nd Stage, Inline Adjusting Tool - 3/16" Hex (p/n 347-0002) to turn the seat (18) counterclockwise enough turns to fully disengage the threads from the valve tube (21).

5.2.23 After the threads are disengaged, remove the seat (18) from the valve tube (21) by pulling and turning counterclockwise at the same time. The seat will usually come out on the end of the Allen wrench. If it will not come out, it can be pushed out with a soft wooden dowel however, care must be taken not to damage the seat if it is pushed out.

5.2.24 Remove and discard the O-ring (17) from the seat.

## 5.3 CLEANING AND INSPECTION OF THE 2nd STAGE

5.3.1 Rinse all plastic and silicone parts in a fresh warm soapy water solution. Rinse with clean warm water and then blow the parts dry with compressed air to remove any sand and dust particles.

5.3.2 If necessary because of deposits or corrosion, clean all metal parts of the second stage in an ultrasonic cleaner or cleaning solution. See Section 6.3 for recommendations on cleaning solutions.

5.3.3 Inspect the housing (10) for any cracks or nicks. Look particularly closely at the area where the exhaust valve (14) seals and where the heat sink (8) clamps. Replace the housing if any cracks are found.

5.3.4 Inspect the sealing surface on the seat (18) where the seating seal (22) seals for any nicks or scratches. Replace the seat (18) if any serious defects are found at the sealing area, or if the threads appear worn out.

5.3.5 Blow all dust and debris out of the orifice with clean compressed air.

5.3.6 Inspect the exhaust valve (14). Look carefully at the base of the barbed nipple where it comes out of the middle of the valve. Look for any tearing at this point. Replace the valve if any tears are found. Replace the valve if nicks or tears are found at the sealing edges of the valve.

5.3.7 During an Annual Overhaul, all parts included in the Annual Service Kit are replaced no matter what the condition of those parts. Carefully examine all other parts of the second stage for signs of deterioration. Replace those parts too where necessary.

**IMPORTANT: Do not lubricate the O-ring (9) that goes over the valve tube (21) male threaded end.**

## 5.4 PRELIMINARY ASSEMBLY OF THE SECOND STAGE

5.4.1 Ensure that all parts are clean. To determine the identity of each O-ring in the Second Stage Service Kit, remove them from the bag and use the O-ring Identification Chart on the back page of this section. Lay each O-ring over its corresponding picture on the page and read the description.

**IMPORTANT: Do not lubricate the O-ring (9) that fits over the end of the valve tube (21).** Before installing new O-rings into the regulator, lightly lubricate the O-rings with LTI Christo-Lube 111® (**EXCEPT O-ring (9) that goes over the valve tube (21) male threaded end**).

5.4.2 Install the exhaust valve (14) into the case by inserting the nipple into the square hole from the outside of the case. Reach inside the case and pull the nipple firmly with the fingers until you hear or feel it "click" into place. Inspect the exhaust valve to see that it is properly seated. Take care not to get any lubricating grease on the exhaust valve during this procedure.

5.4.3 Install a new O-ring (27) onto the outside of the valve tube (21).

5.4.4 If the lever (19) was removed, carefully re-fit it into the valve tube (21). To orient the lever properly, hold the valve tube with the external threads to the right. Turn the valve tube until you can see the hole where the air exits the valve tube (indicated by pencil tip in photo). The lever is inserted so that it leans to the left. See Photo 6. Work the lever into the valve tube one foot at a time so the lever legs are spread outwards as little as possible.

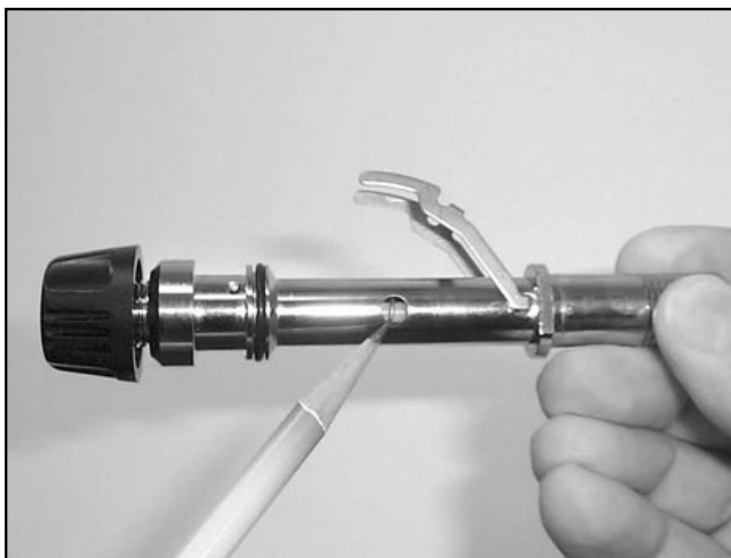

**Photo 6**

5.4.5 Insert the new seating seal (22) into the white piston (23).

5.4.6 Install the lubricated small O-ring (24) onto the piston tip.

5.4.7 Install the spring (25) onto the piston and the balance cylinder (26) onto the piston to make the shuttle valve assembly.

5.4.8 Insert the shuttle valve assembly you have just assembled into the valve tube (21) at the end with the raised collar (opposite the external threaded end). See Photo 7.

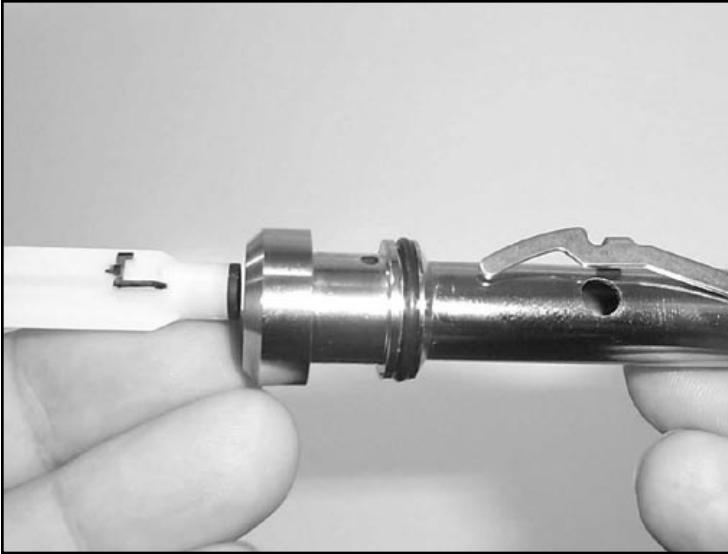

**Photo 7**

5.4.9 When the shuttle assembly is inserted into the valve tube, it is important that the “L” shaped foot on the piston section engages properly with the lever tabs that extend through the holes in the valve tube. In Photo 7, the “L” shaped foot has been highlighted with black marker so you can see the “L” clearly. The piston is normally all white.

5.4.10 Insert the shuttle valve assembly as shown in Photo 7. Push the assembly all of the way into the valve tube. The first thing that might hang up on the tabs of the lever is the black seating seal. Wiggle the lever to get this past the tabs. When the “L” shaped feet get to the lever tabs they will lift the lever outwards as you push the assembly in.

5.4.11 Install a new well lubricated O-ring (28) onto the spring adjuster knob assembly (29).

5.4.12 Insert the spring adjuster knob assembly into the valve tube over the shuttle valve assembly you just installed.

5.4.13 Turn the spring adjuster knob assembly clock-wise until the O-ring and flange have passed the hole where the pin (20) is installed.

5.4.14 Install the pin (20) into the valve tube (21).

5.4.15 Back the spring adjuster knob assembly out counter-clockwise until it tightens against the pin (20) holding it in place.

5.4.16 Install the new O-ring (15) onto the venturi control lever (16).

5.4.17 While holding the tabs in place in the valve tube with two fingers, depress the lever (19) and the slide the venturi control lever (16) into place on the valve tube (21).

5.4.18 Install the valve tube assembly into the housing (10). After assembly, make sure that the pivot end of the lever is held into the valve tube (21) by two plastic flanges on the housing just as they did when you took the housing apart (see step 5.2.7)

5.4.19 Install the O-ring (9) over the external threaded end of the valve tube (21).

**IMPORTANT: DO NOT LUBRICATE THIS O-RING!**

5.4.20 Install the heat sink (8) over the external threaded end of the valve tube.

5.4.21 Install the nut (7) over the external threaded end of the valve tube. Tighten the nut snugly 1-2 ft/lb (2-3 Nm) with a wrench.

5.4.22 Install the new lubricated O-ring (17) onto the seat (18).

5.4.23 Use the 3/16" Allen wrench or the 2nd Stage, Inline Adjusting Tool - 3/16" Hex (p/n 347-0002) to install the seat into the valve tube.

5.4.24 Tighten the seat (18) clockwise with the Allen wrench or Inline tool. It is important that the final adjustment of the seat leaves the lever with just a little (2-3 degrees of arc) free movement to allow for the natural wear of the seating seal (22) during the use of the regulator. Adjust the seat (18) in while watching the tip of the lever (while holding the housing so that the lever is faced upwards). Stop turning the seat (18) as soon as the lever droops, or is loose enough to have 2-3 degrees arc of free play. See Photo 8. Without this free-play the second stage will begin to hiss slightly after just a few hours use.

**Note:** Depress the lever (19) while moving the seat with the wrench. This prevents premature indentation and wear of the seal (22).

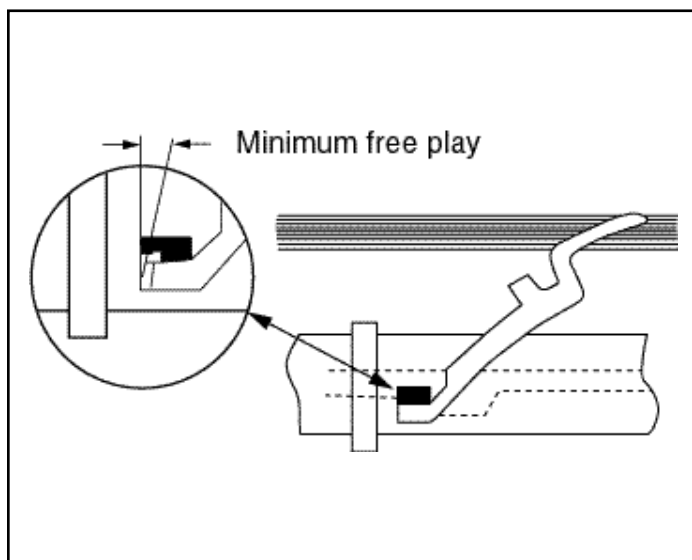

**Photo 8**

5.4.25 Install the exhaust tee (13) onto the case by hooking the tee over the flat part of the flange and then working it over the rest of the flange. This operation is made much easier if the tee is immersed for one minute in hot tap water to soften it temporarily.

## 5.5 SET- UP OF THE SECOND STAGE

For the following adjustments, the cover and diaphragm must be removed.

5.5.1 Turn the spring adjust knob assembly (29) out counter-clockwise all the way. Note: Some models use a plastic spring adjust plug (35) instead of a knob assembly. Use a 1/4" Allen wrench to turn the plastic plug.

5.5.2 Install the new O-rings (31,33) onto the hose assembly (30). Install the hose between a serviced first stage and the second stage, tighten snugly. Use two wrenches to tighten the second stage hose connection.

**Note:** Attach the second stage to the overhauled and properly adjusted first stage that it is going to be used with, mounted on an air tank filled to between 2700 and 3500 psi. Install an intermediate pressure gauge into one of the low-pressure ports.

5.5.3 *Carefully turn the air on.* After adjusting the second stage as outlined in assembly step 5.4.24 in this manual, the lever (19) should be slightly loose against the “L” shaped foot of the shuttle valve assembly. See Photo 7. There should be about 1/32” (.8 mm) of free play at the end of the lever. There should be no air leaking from the second stage with proper intermediate pressure applied to the hose. If there is air leaking from anywhere on the second stage, correct the problem before going further. The best test to check for the slightest leaks is to immerse the second stage (with no cover or diaphragm installed) under pressure in water and look for bubbles indicating a leak. Correct the problem if leaks are found. See Troubleshooting section 6.1 for help.

5.5.4 Work the lever up and down a few times while the regulator is pressurized. Each time the lever is released, no air hissing should be heard.

## 5.6 FINAL ASSEMBLY OF THE SECOND STAGE

5.6.1 Install the diaphragm (4) into the housing (10) so that it sits evenly on the ledge.

5.6.2 Install the diaphragm cover (3) over the diaphragm. Push the cover firmly over the diaphragm so the diaphragm is seated properly.

5.6.3 Install the purge dome (2) into the cover ring (1).

5.6.4 Screw the purge dome and cover ring into housing. Adjust the purge dome in the cover ring so that the Zeagle logo sits properly when the cover ring is tightened firmly hand tight.

5.6.5 Install the mouthpiece (12). Be sure to position the mouthpiece so that the overbite where the top teeth fit, is on the top.

5.6.6 Install the TWO new mouthpiece ties (11) from the service kit. Position one of the tie locks on each side of the mouthpiece. Tighten both ties securely and cut off excess.

5.6.7 Slide the hose nut cover (6) back over the hose connection.



NEVER tighten the hose with more than 40 in. lbs. (4.5 Nm) of torque. The inlet hose fitting can be weakened by over tightening.



## 5.7 TESTING OF THE SECOND STAGE

### A. INHALATION EFFORT:

5.7.1 With air pressure applied, turn the spring adjuster knob fully counter-clockwise. Move the venturi lever to the "+" position. Depress and release the purge dome. A large continuous free-flow should result. Move the venturi lever towards the "-" position. With no other intervention, by the time you get the lever 2/3 of the way to the "-" position the free-flowing should stop. This test shows the regulator is performing as it should. It is not necessary, but you can perform further inhalation tests.

5.7.2 If you have no instrumentation, breathe on the regulator to test the breathing effort. With the adjusting knob turned fully clockwise, and the venturi lever in the full "-" (pre-dive) position, the regulator will be relatively hard to inhale on but the purge dome must still purge when depressed.

5.7.3 With the adjusting knob turned fully counter-clockwise, and the venturi lever in the full "+" (dive) position the regulator will be easy to inhale on. It is important to note that although the breathing efforts are very different in these two positions, the ultimate air delivery capacity of the regulator is essentially the same in either position.

5.7.4 If a water column or water manometer is used to check inhalation effort, it should not exceed 2" (50 mm) w. c. at cracking with the adjuster knob in the minimum effort position.

**Note:** *These Zeagle regulators have been designed and built to perform with the "Best of the Best" in underwater breathing effort. They also have design features that were influenced by the desire to make the regulator stable and resistant to freezing and free-flows. The regulator is VERY easy breathing underwater, and yet resists going into free-flow by just being bumped on the surface.*

*One important result of this dual personality is that the "Cracking Effort" test on the surface will reveal a relatively high (compared to less stable regulators) cracking effort of 1.4 to 2" (36-51 mm) water column. This is deliberately designed into the regulator for stability and freezing resistance reasons and IN NO WAY relates to underwater performance. If the technician wants to lower the cracking effort to the lower end of the range, refer to the trouble shooting section of this manual (6.1).*

5.7.5 Move the venturi adjusting lever (16) through its full range of movement while inhaling on the regulator. You should feel an easier inhalation effort in the "+" position than the "-" position.

### B. EXHALATION EFFORT:

5.7.6 If you do not use instruments to check the exhalation effort, the flow should feel smooth and unrestricted.

5.7.7 If you use a water column, it should not exceed 1/2" w.c. (13 mm) at one atmosphere.

5.7.8 Brand new exhaust valves will sometimes adhere slightly to the case, causing a slight increase in exhalation effort. This condition will disappear with use.

### C. LEAK TEST:

5.7.9 Disconnect the air supply. Purge the regulator of all positive air pressure.

5.7.10 Slowly immerse the second stage in a pan of water with the mouthpiece pointing straight up.

5.7.11 Immerse the regulator until the water is 1/4" to 1/8" (.64 to .32 cm) from the lip of the mouthpiece.

5.7.12 Hold the regulator in this position for one minute and then slowly raise it out of the water.

5.7.13 Tip the regulator mouthpiece downward and watch the inside of the mouthpiece tube. If any water escapes from the mouthpiece tube, check for the source of the leakage.

### D. INTERMEDIATE PRESSURE AIR LEAKS:

5.7.14 Attach the regulator first stage to a tank short enough to totally submerge the first and second stage in your filling station cooling water. Adjust the breathing effort knob to the minimum breathing effort position.

5.7.15 With the tank valve still turned off, flood the second stage completely with water, and then position it mouthpiece up.

5.7.16 Turn the tank air valve on slowly and then watch for any leaks in the first or second stage. If leaks are seen coming from the second stage, repeat the test with the cover assembly removed. You will be able to see more clearly exactly where the leak is coming from.

5.7.17 Repair any leaks.

## 6.0 HELPFUL HINTS

### 6.1 TROUBLESHOOTING

#### A. HIGH INHALATION EFFORT AT DEPTH:

#### POSSIBLE CAUSE

#### RECOMMENDED ACTION

Inlet filter clogged.	Replace the filter.
Air supply to 1st stage insufficient.	Verify the supply air pressure. Make sure the customer had the air valve turned all the way on during the dive.
1st or 2nd stage improperly adjusted	Refer to sections 4.5 and 5.5 of this manual.

## A. HIGH INHALATION EFFORT AT SURFACE (cracking effort in air):

POSSIBLE CAUSE	RECOMMENDED ACTION
----------------	--------------------

1st or 2nd stage improperly adjusted.	Refer to sections 4.5 and 5.5 of this manual.
2nd stage spring force on high end of range	<p>The spring (25) can be conditioned to a lower thrust. This is done by squeezing it down (with a vise or fingers) to near solid height (.350") where the space between the coils is the same as the thickness of the spring wire. Do not squeeze the spring coils completely closed as this will result in too low a cracking effort.</p> <p>Note: This will lower the cracking effort in air, but will have little or no effect on the underwater performance. It is usually not necessary and should only be done if the customer understands that a low cracking effort makes a regulator more prone to hissing and will probably need more frequent adjusting. If the spring is over squeezed during this conditioning, so that the coils touch each other, the 2nd stage may hiss when the adjust knob (29) is turned all of the way out. Turning the knob in (clockwise) slightly will stop the hissing if this is the case. If the hissing does not stop, the seat (18) needs adjusting, or the seal (22) needs replacing.</p>

## B. CREEPING INTERMEDIATE PRESSURE:

POSSIBLE CAUSE	RECOMMENDED ACTION
----------------	--------------------

Damaged or worn 1st stage seat (12).	Replace seat
Damaged or worn seat O-ring (13)	Replace O-ring
Worn O-ring (32) on HP valve stem.	Replace O-ring
Scratch in groove where O-ring (32) seals	Replace HP balance plug (35) or turret bolt (41)
Nick in sealing surface of HP valve (30)	Replace HP valve

## C. HISSING FROM SECOND STAGE (but intermediate pressure is OK):

POSSIBLE CAUSE	RECOMMENDED ACTION
----------------	--------------------

Damaged or worn 2nd stage seating seal (22)	Replace seating seal
Nicked seat (18) sealing surfaces	Replace seat
2nd stage demand lever (19) bent too high	Replace lever
Worn O-ring (24) on piston (23)	Replace O-ring
Damaged O-ring groove on piston (23)	Replace piston
Worn O-ring (17) on seat (18)	Replace O-ring
Worn O-ring groove on seat (18)	Replace seat
Seat (18) out of adjustment	Adjust Seat

### C. WET BREATHING:

POSSIBLE CAUSE	RECOMMENDED ACTION
Diaphragm improperly installed or hole in diaphragm	Check position of diaphragm visually. Replace if holes found by holding up to a light.
Damaged or loose fitting exhaust valve	Replace exhaust valve (14)
Crack in housing (10)	Replace housing
Worn venturi lever O-rings (15, 27)	Replace O-rings (15, 27)
Scratched or worn venturi lever sealing surfaces	Replace venturi lever (16)
Scratched or worn housing (10) sealing surfaces	Replace housing
Improper clearing techniques by diver	Instruct diver on clearing techniques
Extremely slow breathing allowing water to build up in housing rather than being blown out	Explain this result of slow breathing to diver.

### D. HIGH FREQUENCY HUMMING OR BUZZING DURING INHALATION:

POSSIBLE CAUSE	RECOMMENDED ACTION
Harmonic resonance between the springs and other 1st stage components.	Remove the main spring (7) flip it over and re-install.
“ “	Replace spring or other components until resonance stops.

### E. LOW FREQUENCY FLUTTERING DURING INHALATION (Above the surface only):

POSSIBLE CAUSE	RECOMMENDED ACTION
Harmonic resonance between the springs and other 2nd stage components.	Remove, rotate and re-install diaphragm or switch diaphragm with another.
“ “	Replace seating seal (22)
“ “	Remove, rotate and re-install spring (25)
“ “	Explain to the customer that this is not harmful to the regulator, and does not happen underwater.
“ “	Move venturi lever (16) towards "-" position until harmonic resonance stops.

## 6.2 PARTS CLEANING RECOMMENDATIONS

6.2.1 Regulators that see heavy use, particularly those used in salt water, often require extra effort to remove dirt and corrosion from the parts of the regulator. Some suggested cleaning solutions are listed at the end of this section, and there are probably many others being used successfully. The following are a few general suggestions we can make.

6.2.2 Don't expect your cleaning solution to do all the work in a matter of seconds. If the solution cleans extremely rapidly, it is probably too strong and is etching the finish on the parts. Use a wooden or plastic stick or a soft bristle brush to help get rid of the thickest deposits. Take special care not to damage orifice sealing areas.

6.2.3 Soft parts absorb ultrasonic energy. Remove all O-rings and seals from metal parts before cleaning them. If possible, do not clean plastic parts with the metal parts, or at least understand that every plastic part you put into the ultrasonic cleaner is slowing down the ultrasonic cleaning process for the rest of the parts.

## 6.3 COMMONLY USED CLEANING SOLUTIONS

SOLUTION	COMMENTS
Hot Soapy water	Preferable. Good for plastic, silicone and plated metal parts.
Vinegar and water (equal part solution) (weaker solution in Ultrasonic Cleaner)	Ingredients easily available. Approx. 15 min. cleaning time. May damage chrome finish. Never use on plastic parts. Vinegar dissolves the plastics in most polymers making them brittle and more prone to breakage.
Simple Green ® and Water	Simple Green ® is a readily available degreaser. Read the product label for mixing ratios with water.
Cleaning solutions recommended by ultrasonic cleaner manufacturers	The preferred choice. Check with the manufacturer for strengths and recommended uses for their cleaners. Choose soap solutions over acidic

## 6.4 HANDLING TIPS

How your customers treat their regulators will directly influence the unit's function and durability. Following are a few tips that you can pass on to your customers to help assure the durability of their Zeagle Scuba Regulator.

### A. PRE-DIVE CHECKS:

6.4.1 Check the hoses and hose connections for cuts, abrasions or other signs of damage before mounting the regulator on the tank valve. Slide the hose protectors back to inspect the areas of the hose normally covered. Be sure all hose connections are tight.

6.4.2 Just before mounting the regulator on the valve, always turn the valve on briefly to blow any trapped water out of the valve. There is often salty water trapped in the outlet side of the valve. This entrapped salt water being blown through the interior of the regulator is the number one source of internal corrosion and problems with Scuba regulators.

6.4.3 Before turning on the tank air valve, check to make sure that the yoke nut or DIN connection is tight and the regulator body is aligned properly, with no kinks in the hoses.

6.4.4 Turn the tank valve on slowly and listen for leaks. If any leaks are found, replace or repair parts as recommended.

6.4.5 Never lift the tank/BCD assembly by the regulator or hoses.

6.4.6 Surface-test the regulator by breathing lightly through the mouthpiece. Depressing the purge button above the water's surface is not an effective or thorough method for testing the function of the regulator.

## **B. POST-DIVE CARE:**

6.4.7 After the dive, blow all water out of the dust cap with clean dry air or dab the water out with an absorbent cloth and place the cap securely on the regulator inlet. On multiple tank dives, use great care to keep salt water out of the regulator inlet when tanks are changed. Neglecting these simple procedures is another great cause of corrosion and wear in Scuba regulators. Zeagle's Dry Seal System keeps all other water-borne contamination out of the first stage body.

6.4.8 With the dust cap securely in place, rinse the first and second stages in clean fresh water. DO NOT depress the purge button before or during rinsing since this may introduce water into the second stage and the low-pressure hose. Shake or blow all excess water from the second stage and allow the entire regulator to air-dry before storing.

6.4.9 Store regulator in a clean bag or storage box, away from sunlight, excessive heat and humidity.

## **7.0 WARRANTY AND MAINTENANCE INFORMATION**

### **7.1 PROPER PROCEDURE FOR SERVICE PAPERWORK (USA)**

7.1.1 Make sure your service location has an adequate supply of the three part "Zeagle Service Order / Parts Request" forms. One of these carbon-paper forms is required to get credit for parts used in any warranty replacement. Contact Zeagle Customer Service for replacement forms.

7.1.2 When the regulator is received from the customer for servicing, verify that they are the original retail owner of the regulator and that they have had the regulator serviced annually at an Authorized Zeagle Dealer. You can use your records for this, or receipts they have. If they are not the original owner or have not had the regulator serviced annually, the warranty is no longer in effect.

7.1.3 Fill out the Zeagle Service Order / Parts Request form. PRINT CLEARLY! If you use service kits, you only have to use the service kit part number(s) to represent all of the parts in that kit. Parts other than those in the kits have to be listed individually. The reason for replacing the part also has to be listed on the form.

7.1.4 Attach all of the old parts that were replaced under warranty in a plastic bag and attach it to the Zeagle Service Order / Parts Request form.

7.1.5 If a body or housing is replaced, the replacement parts will have different new serial numbers. Note the new serial # in "Description of Part" section of the Zeagle Service Order / Parts Request form. Write the old number in the Serial # section. The dive store and the customer should keep records of this serial number change. Use the new numbers in future warranty claims.

7.1.6 Contact Zeagle Customer Service and ask for an RA (Return Authorization) number for each group of Zeagle Service Order / Parts Request forms you are going to send in. **YOU MUST GET A RA# BEFORE RETURNING ANY PARTS TO ZEAGLE.** Due to high volume and a desire to move promised items through the service department quickly, boxes arriving without a RA# will be put at the end of the line and will be opened when all other work on properly RA numbered items is finished. This could delay your items by weeks during peak season!

7.1.7 Write the RA number on the Zeagle Service Order / Parts Request form. Mail the forms with attached parts bags to Zeagle. You will receive credit or replacement parts **ONLY** if an RA number is printed on the form.

7.1.8 If you are servicing Zeagle regulators outside of the United States, your return procedures may be different. Check with your regional Zeagle Distributor for details.

RA # (fill your RA # in here)  
37150 Chancey Road  
Zephyrhills, Florida 33541  
U. S. A.

## **7.2 SCHEDULED MAINTENANCE**

7.2.1 To keep the owner warranty in effect, your customers must have their regulators inspected and serviced annually (within six weeks before or after the anniversary of the date of purchase) by an authorized Zeagle Dealer. Failure to do so invalidates the warranty.

7.2.2 Even with infrequent use, the regulator should be serviced annually to ensure proper performance and satisfy warranty requirements.

7.2.3 After calling Zeagle Customer Service at (813) 782-5568 for an RA number, Zeagle Scuba parts and warranty forms are sent to the following address:

Zeagle Scuba Warranty Department



**Order Form** (sample)

This is a copy of the Service Parts Request Form. The actual form is a three-page carbon copy that is available by request from Zeagle Customer Service. If you do not have any forms on hand, you may photocopy this page and use it to receive warranty parts credit.

## Service Order / Parts Request Form



This form must be used by the Service Center  
for ANY Warranty Servicing

You MUST contact Zeagle for an RA  
Number to receive any Warranty Credit

37150 Chancey Rd.  
Zephyrhills, FL 33541  
(813) 782-5568  
Fax (813) 782-5569  
www.zeagle.com

Zeagle Service Center: City, State (Prov), Country: Phone / E-mail:			
Date Serviced:		Technician Name (PRINT): Technician Number:	
Customer Name: Address: City, State (Prov), Country: Phone / E-mail:			
RA # (call Zeagle): _____			
1st Stage Model: _____		Serial #: _____	
2nd Stage Model: _____		Serial #: _____	
Octopus Model: _____		Serial #: _____	
Comments:			
<b>Part # Installed</b>	<b>Description of Part</b>	<b>Warranty Item? Y/N</b>	<b>Customer Price</b>
345-1000	First Stage Service Kit		
345-2000	Second Stage Service Kit		
Note: If a body or housing is replaced, note the new serial # in "Description of Part"			<b>Total:</b>

I am the original (first) owner of this equipment being serviced. Yes \_\_\_\_ No \_\_\_\_

Customer's Signature: \_\_\_\_\_ Date: \_\_\_\_\_

The customer must provide proof of original ownership (receipts, etc.) before any "in Warranty" service can be performed.

Service Center: Be sure this form is completely filled out, signed by the customer and returned to Zeagle for credit on warranty parts.





37150 Chancey Road  
Zephyrhills, Florida 33541  
U. S. A.

Zeagle Scuba, the Zeagle symbol, ZX, 50D, DS-IV and Flathead VI are trademarks of Zeagle Systems Inc. All other names are trademarks of their respective owners. All products subject to change without notice.

Zeagle Web Site [www.zeagle.com](http://www.zeagle.com)  
Contact Zeagle by E-mail at [info@zeagle.com](mailto:info@zeagle.com)

© 2001 Zeagle Systems Inc.  
Printed in USA

Part Number for this Manual (p/n 147-2000)